

 **STOP VALVE zGLO**



Body material	Nominal pressure	Nominal diameter	Max. temperature
A Grey cast iron	C 16 bar	DN 15-50	200°C









correspond to the pressure equipment directive 2014/68/UE marking CE for DN≥32

**FEATURES**

- high tightness (leakproofness class - A acc. to EN -12266 - 1)
- compact settlement
- environment-friendly
- tests acc.to EN - 12266 - 1

**APPLICATION**

industries				
	INDUSTRY	HEATING		
media				
	INDUSTRIAL WATER	STEAM	COMPRESSED AIR	NEUTRAL FLUIDS

Data given can be changed without notice.

Edition 01/2018

FIG.201

MATERIALS, DIMENSIONS

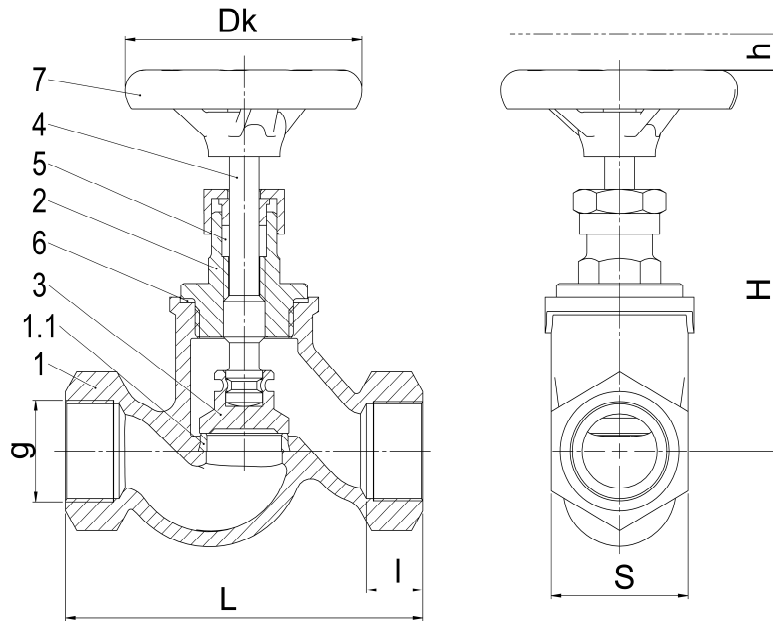

	Body material	A
	Type	00
1	Body	EN – GJL-250 5.1301 (ex. JL1040)
1.1	Seat ring	X12Cr13 1.4021
2	Bonnet	EN – GJL-250 5.1301 (ex. JL1040)
3	Disc	X20Cr13+QT 1.4021
4	Stem	X20Cr13 1.4021
5	Packing gland	Graphit
6	Gasket	Carbamide - rubber
7	Hand-wheel	EN – GJL-250 5.1301 (ex. JL1040)
<b>Max. temperature</b>		<b>200°C</b>

DN	10	15	20	25	32	40	50
L (mm)	85	90	100	120	140	170	200
Dk (mm)	64	64	64	80	80	100	100
H ((mm)	105	109	109	129	152	167	178
h (mm)	7	9	9	9	13	18	20
g	G 3/8	G 1/2	G 3/4	G 1	G 1 1/4	G 1 1/2	G 2
l (mm)	12	14	16	18	20	22	24
S (mm)	30	32	41	46	55	60	75
k <sub>vs</sub> (m <sup>3</sup> /h)	2,4	4,5	6,1	10,1	17,9	25,4	40,5
Weight (kg)	0,7	0,9	1,0	1,45	2,1	3,0	4,3

Data given can be changed without notice.

Edition 01/2018

**PRESSURE-TEMPERATURE RATINGS**

Acc. EN 1092-2	PN		-10°C÷120°C	150°C	200°C
EN-GJL250	16	bar	16	14,4	12,8

**TYPE**

Figure	Body material	Nominal diameter	Nominal pressure	Type
201	A Grey cast iron EN-GJL-250	15-50 mm	C 16 bar	00 stem and disc connection - fixed – rolled; stem, disc and seat ring - stainless steel
		15-50 mm	C 16 bar	08 stem and disc connection - fixed – rolled; stem, disc and seat ring - stainless steel disc gasket PTFE

**ORDERING**

Figure	Body material	Nominal diameter	Nominal pressure	Type
201	A Grey cast iron EN-GJL-250	15-50 mm	C 16 bar	00 stem and disc connection - fixed – rolled; stem, disc and seat ring - stainless steel

**Order example acc. index**

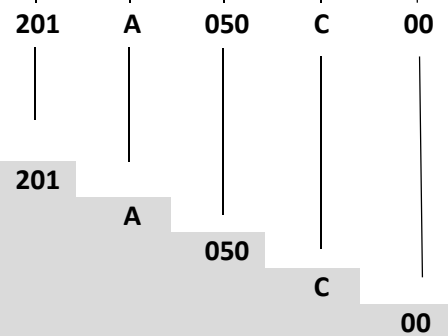

Stop valve, ends threaded, form straight  
 Grey cast iron EN-GJL-250  
 Nominal diameter (mm)  
 Nominal pressure PN 16  
 Stem and disc connection - fixed – rolled; stem, disc and seat ring - stainless steel

Data given can be changed without notice.

Edition 01/2018